

**1. Description.**

The PC2 timing relay module is intended for AC power status control in object alarm systems (monitoring transmitters, alarm control panels, DC power supply units, etc.). The module informs about AC power loss with a preset delay time – T (3s/63s/17m37s/4h45m, +/-2%) and its return. Momentary return of the AC power during the T delay countdown will reset the countdown (stop and return to normal state). The module is equipped with an AC1 input which shall be connected to one of the secondary winding of the transformer that supplies the device (the module must be powered with 12V/DC of the device to which the controlled terminal of the transformer is connected). PC2 has two OC outputs (OC1, OC2) and an LED (L1) indicating the device's status. Delay time indicating AC power loss is adjustable via two jumpers – Z1, Z2.

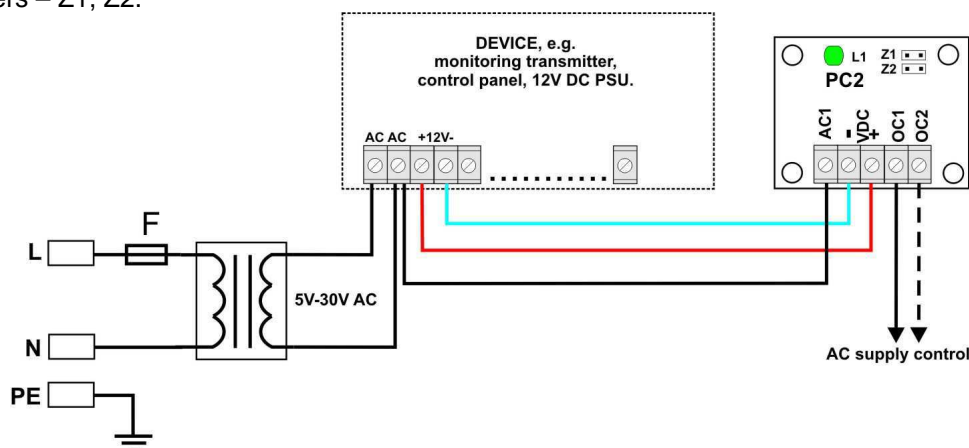











Fig.1. A diagram of the PC2 connection (example).

**2. Description of components and connectors of the module.**

Nr [rys.2]	Description
[1]	<p><b>L1 green LED</b> - module's status indication</p> <ul style="list-style-type: none"> <li>permanently illuminated: presence of AC power at AC1 terminal, presence of VDC power of the module</li> <li>twinkles 1x/1s: no AC power at AC1 terminal, delay time countdown</li> <li>off: the module has finished the countdown and changed the status of OC outputs (alternatively - no 12V DC power)</li> </ul>
[2]	<p><b>Z1, Z2 jumpers</b> - adjustable time delay of AC power failure indication</p> <ul style="list-style-type: none"> <li>Z1= , Z2=  <b>time delay T= 3s</b></li> <li>Z1= , Z2=  <b>time delay T= 1 min 5s</b></li> <li>Z1= , Z2=  <b>time delay T= 17 min 40s</b></li> <li>Z1= , Z2=  <b>time delay T= 4h 45 min</b></li> </ul> <p> <b>jumper on</b>  <b>jumper off</b></p>
[3]	<p><b>Connectors</b></p> <p><b>AC1</b> – input of controlled AC voltage (one of terminals of the transformer's secondary winding)</p> <p><b>+VDC</b>- DC power input</p> <p><b>OC1</b> - OC output (open collector) indicating AC power status:</p> <ul style="list-style-type: none"> <li>normal state: L (0V, GND),</li> <li>active state: hi-Z (high impedance)</li> </ul> <p><b>OC2</b> - OC output (open collector) indicating AC power status:</p> <ul style="list-style-type: none"> <li>normal state: hi-Z (high impedance)</li> <li>active state: L (0V, GND) OC type</li> </ul> <p><b>Normal state:</b> AC voltage presents at the AC1 terminal or after AC power loss <b>Active state:</b> no AC voltage at the AC1 terminal, delay time countdown is finished</p>

### 3. Specifications.

<b>Supply voltage</b>	10 V ÷ 15 V DC
<b>Current consumption</b>	5 mA
<b>T delay adjustment range</b>	3s/1min 5s/17min 40s/4h 45min (-2%/+2%)
<b>AC1 input</b>	0V ÷30V AC L state ('0' logic)= 0V ÷1,5V AC H state ('1' logic)= 5V ÷30V AC GND= 'VDC-' power terminal
<b>Technical outputs:</b>	OC type 50mA max.
- OC1 output	<ul style="list-style-type: none"> <li>normal state: L (0V, GND),</li> <li>active state: hi-Z (high impedance)</li> </ul>
- OC2 output	<ul style="list-style-type: none"> <li>normal state: hi-Z (high impedance)</li> <li>active state: L (0V, GND)</li> </ul>
<b>LED indication</b>	L1 green LED
<b>Operating conditions</b>	II environmental class, -10°C ÷ 50°C
<b>PCB dimensions</b>	42 x 35 x 23 (WxHxD)
<b>Installation</b>	installation tape or installation bolt x2
<b>Connectors</b>	Φ0,41÷1,63 (AWG 26-14)
<b>Net/gross weight</b>	0,03kg /0,05 kg
<b>Declarations, warranty</b>	CE, RoHS, 2 year from the production date

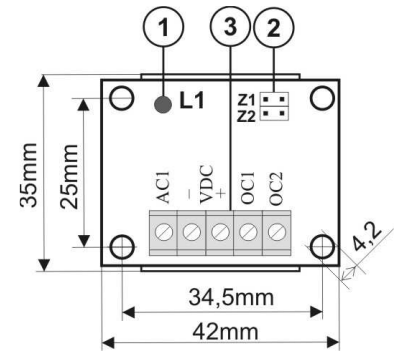

Fig.2. The view of the PC2 module.

### 4. Installation.

The module is to be mounted by a qualified installer, holding relevant permits and licenses (applicable and required for a given country) for 230V/AC and low-voltage installations. The unit should be mounted in confined spaces, in accordance with the II environmental class, with normal relative humidity (RH=90% maximum, without condensation) and temperature from -10°C to + 50°C.

The device shall be mounted in a metallic enclosure (a cabinet, a final case). In order to fulfil LVD and EMC requirements, the rules for: power-supply, encasing and screening shall be followed, according to application.

1. Mount the enclosure (cabinet etc.) and lead the cables through the cable ducts.
2. Install the PC2 timing module on spacers or mounting tape (the spacers shall be mounted prior to the enclosure / cabinet installation procedure).
3. Lead the DC supply power to the +VDC, -VDC terminals, keep polarisation.
4. Lead the AC controlled power to the AC1 terminal.
5. Connect the AC power loss signal: OC1 or OC2 (depending on application requirements) to the indicating device (LED, transmitter's input, control panel's input, indicator, etc.)
6. With Z1, Z2 jumpers, choose the indication delay time of the OC1 and OC2 outputs.
7. Once the tests and operation control have been completed, the enclosure / cabinet can be locked.

#### WEEE PARKING

According to the EU WEE Directive – It is required not to dispose of electric or electronic waste as unsorted municipal waste and to collect such WEEE separately.

#### WARRANTY

Pulsar K. Bogusz Sp.j. (the manufacturer) grants a two-year warranty for the equipment, counted from the device's production date.

#### Pulsar K.Bogusz Sp.j.

Siedlec 150, 32-744 Łapczyca, Poland  
Tel. (+48) 14-610-19-40, Fax. (+48) 14-610-19-50  
e-mail: [biuro@pulsar.pl](mailto:biuro@pulsar.pl), [sales@pulsar.pl](mailto:sales@pulsar.pl)  
http:// [www.pulsar.pl](http://www.pulsar.pl), [www.zasilacze.pl](http://www.zasilacze.pl)